

GaAs SPDT 2.7 V High Power Switch DC - 3.0 GHz

Rev. V3

Features

- Low Voltage Operation: 2.7 V
- High IP3: +56 dBm
- Low Insertion Loss: 0.30 dB at 1 GHz
- High Isolation: 25 dB at 1 GHz
- SC70 6-Lead Package
- 0.5 micron GaAs PHEMT Process

Description

The MASWSS0117 is a GaAs pHEMT MMIC single pole double throw (SPDT) high power switch in a low cost SC70 6-lead package. The MASWSS0117 is ideally suited for applications where high power, low control voltage, low insertion loss, high isolation, small size and low cost are required.

Typical applications are for CDMA handset systems that connect separate transceiver and/or GPS functions to a common antenna, as well as other related handset and general purpose applications. The MASWSS0117 can be used in all systems operating up to 3.0 GHz requiring high power at low control voltage.

The MASWSS0117 is fabricated using a 0.5 micron gate length GaAs pHEMT process. The process features full passivation for performance and reliability.

Ordering Information¹

Part Number	Package
MASWSS0117	Bulk Packaging
MASWSS0117TR	1000 piece reel
MASWSS0117TR-3000	3000 piece reel
MASWSS0117SMB	Sample Test Board

1. Reference Application Note M513 for reel size information.

Functional Block Diagram

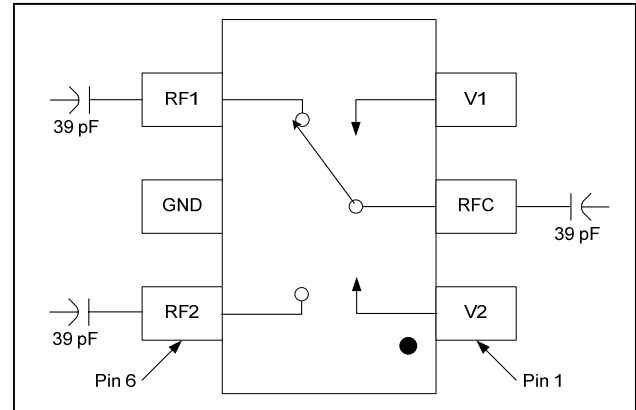

Pin Configuration

Pin No.	Pin Name	Description
1	V2	Vcontrol 2
2	RFC	RF Common
3	V1	Vcontrol 1
4	RF1	RF Port 1
5	GND	RF Ground
6	RF2	RF Port 2

MASWSS0117 orientation in tape

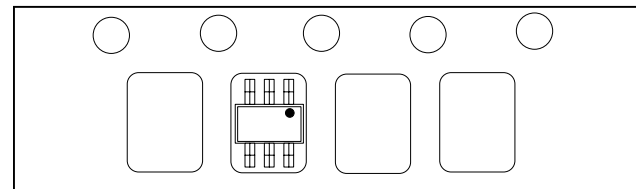

MASWSS0117 Device Marking

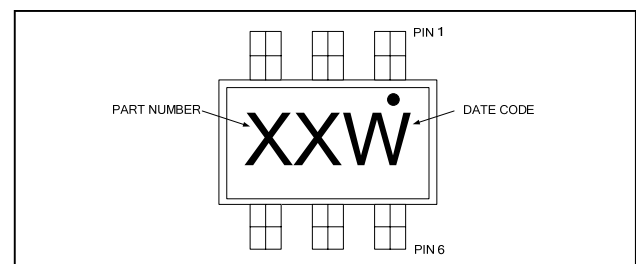

GaAs SPDT 2.7 V High Power Switch DC - 3.0 GHz

Rev. V3

Electrical Specifications: $T_A = 25^\circ\text{C}$, $V_C = 0\text{ V} / 2.7\text{ V}$, $Z_0 = 50\ \Omega^2$

Parameter	Test Conditions	Units	Min.	Typ.	Max.
Insertion Loss ³	DC - 1 GHz	dB	—	0.30	0.65
	1 - 2 GHz		—	0.35	—
	2 - 3 GHz		—	0.35	—
Isolation	DC - 1 GHz	dB	23	25	—
	1 - 2 GHz		—	19	—
	2 - 3 GHz		—	15	—
Return Loss	DC - 3 GHz	dB	—	20	—
IP3	825 MHz Two Tone, +24 dBm Total Pin, 5 MHz Spacing	dBm	—	56	—
Cross Modulation	For Cell Band: Two-tone signal input: Tx1 = +22 dBm @ 820 MHz, Tx2 = +22 dBm @ 821 MHz, RX interfere = -23 dBm @ 869 MHz.	dBm	—	-99	—
	For PCS Band: Two-tone signal input: Tx1 = +18 dBm @ 1880 MHz, Tx2 = +18 dBm @ 1881 MHz, RX interfere = -23 dBm @ 1960 MHz.	dBm	—	-94	—
P0.1dB	1.0 GHz	dBm	—	38	—
Trise, Tfall	10% to 90% RF, 90% to 10% RF	ns	—	70	—
Ton, Toff	50% control to 90% RF 50% control to 10% RF	ns	—	100	—
Transients	In Band	mV	—	25	—
Control Current	$V_C = 2.7\text{ V}$	μA	—	5	20

2. For positive voltage control, external DC blocking capacitors are required on all RF ports.

3. Insertion loss can be optimized by varying the DC blocking capacitor value, e.g. 1000 pF for 100 MHz - 1 GHz, 39 pF for 0.5 - 3 GHz.

Absolute Maximum Ratings^{4,5}

Parameter	Absolute Maximum
Input Power (0.5 - 3 GHz, 3 V Control)	+38 dBm
Operating Voltage	+8.5 volts
Operating Temperature	-40°C to +85°C
Storage Temperature	-65°C to +150°C

- Exceeding any one or combination of these limits may cause permanent damage to this device.
- M/A-COM does not recommend sustained operation near these survivability limits.

Truth Table^{6,7,8}

V1	V2	ANT- RF1	ANT - RF2
1	0	On	Off
0	1	Off	On

- For positive voltage control, external DC blocking capacitors are required on all RF ports.
- Differential voltage, V (state 1) - V (state 0), must be +2.7 V minimum, but must not exceed 8.5 V.
- 0 = -5 V to +2.3 V, 1 = -2.3 V to +5 V.

Typical Performance Curves vs. Frequency, 39 pF

Insertion Loss

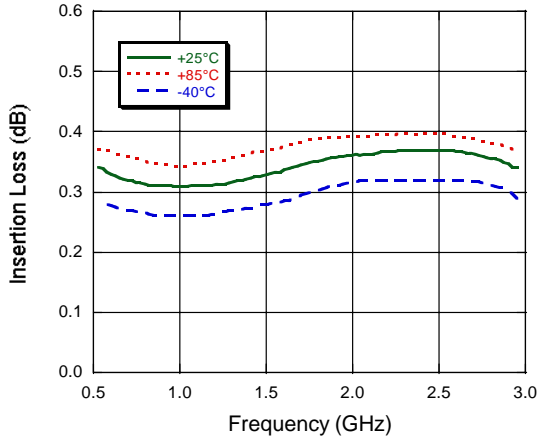

Isolation

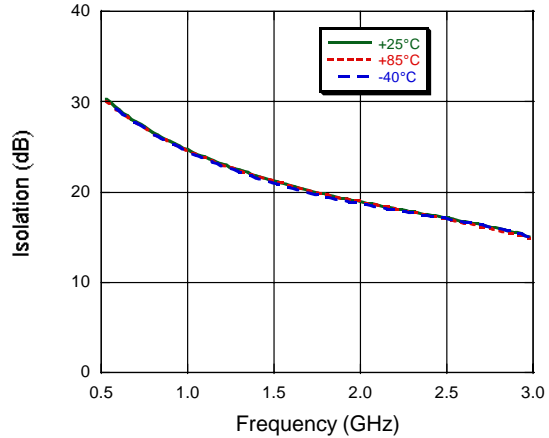

Return Loss

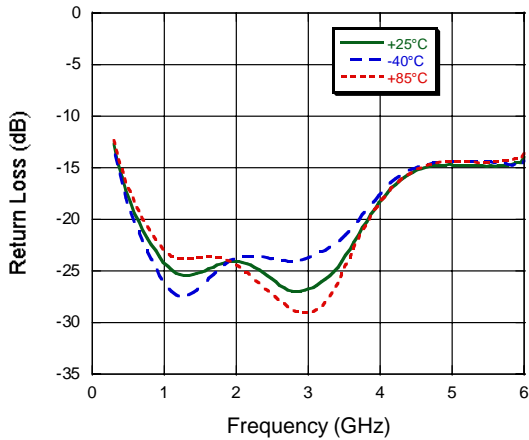

Qualification

Qualified to M/A-COM specification REL-201, Process Flow -2.

Handling Procedures

Please observe the following precautions to avoid damage:

Static Sensitivity

Gallium Arsenide Integrated Circuits are sensitive to electrostatic discharge (ESD) and can be damaged by static electricity. Proper ESD control techniques should be used when handling these devices.

SC-70 Plastic Package†

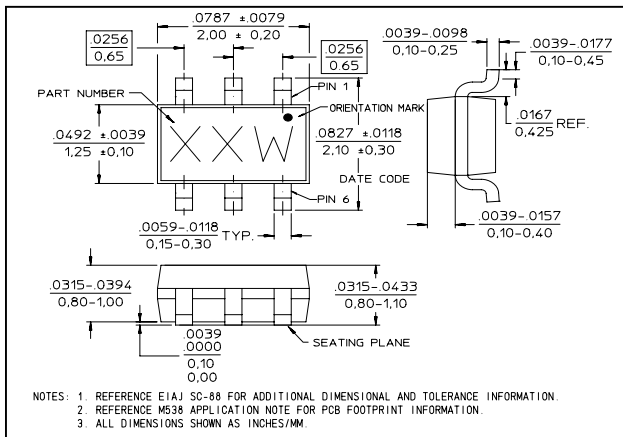

† Meets JEDEC moisture sensitivity level 1 requirements.

ADVANCED: Data Sheets contain information regarding a product M/A-COM Technology Solutions is considering for development. Performance is based on target specifications, simulated results, and/or prototype measurements. Commitment to develop is not guaranteed.

PRELIMINARY: Data Sheets contain information regarding a product M/A-COM Technology Solutions has under development. Performance is based on engineering tests. Specifications are typical. Mechanical outline has been fixed. Engineering samples and/or test data may be available. Commitment to produce in volume is not guaranteed.

• **North America** Tel: 800.366.2266 • **Europe** Tel: +353.21.244.6400
• **India** Tel: +91.80.43537383 • **China** Tel: +86.21.2407.1588

Visit www.macomtech.com for additional data sheets and product information.

M/A-COM Technology Solutions Inc. and its affiliates reserve the right to make changes to the product(s) or information contained herein without notice.